

Fuzzy logic control implementation in sensorless PM drive systems

Kasim M. Al-Aubidy¹ and Ghada M. Amer²

¹ *Computer Eng. Dept, Philadelphia University, Jordan*

² *Benha Higher Institute of Technology, Egypt*

Abstract The PM motor drive systems are becoming particularly popular in many industrial applications. They have many of the desirable performance characteristics of both the AC and DC drive systems. In this paper, a fuzzy logic controller is proposed for the real-time control of a Sensorless PM drive system. An implicit detection method has been used to detect the rotor position and to measure both the rotating speed and internal load angle. The results given in this paper demonstrate the capability of such a drive system in applications where simplicity, reliability and stability are more important issues. Furthermore, the proposed hardware and software design is simple and can be implemented by a single-chip microcontroller for real-time applications.

Keywords: Sensorless drive systems, Rotor detection, Fuzzy logic control, Intelligent systems, Real-time systems.

1. Introduction

With recent developments in magnet materials, it appears that there is an increasing acceptance of permanent magnet (PM) synchronous machines in variable speed drives [1,2,3]. A fast dynamic response and accurate steady state performance can be obtained now by optimal combination of PM machines and microprocessor control. In general, AC motor drive is a nonlinear multivariable system and has complex dynamic performance due to the coupling effect between rotor and stator windings [1]. When such a machine is used in real-time drive systems, it calls for complex control

strategies which would be difficult to implement without the new trends in softcomputing.

There is a lot of literature on the design of AC drive systems for a wide variety of applications. Typical applications include aerospace actuators, computer peripherals, machine tools, robotic drives, and many others [3-5]. Some of these applications require speed control schemes and in some applications the position control is of greater importance. In some cases, the steady state operation is important, and in other cases the dynamic performance is more significant.

Normally, AC drive systems have two modes of operation. One is the open-loop mode, in which an independent oscillator controls the motor speed. The other mode is the closed-loop mode, in which the inverter power switches are controlled directly from the rotor position sensor. An open-loop configuration is the simplest mode since there is no need for a rotor position sensor. The main advantage of this control scheme, apart from simplicity, is that the motor speed can be set very precisely if a high accuracy PWM inverter is used. However, a large load torque will cause pull-out and the motor will stop, therefore closed-loop mode is required. The main objective of the closed-loop mode is to improve the system stability and to achieve torque control over the required speed range.

The self-commutating DC motor drive, which is also called a brushless DC motor, has been the object of many studies [6-10]. These drive systems are becoming particularly popular in many industrial applications, because they have many of the desirable performance characteristics of both the DC and AC motors. In the self-commutating DC drive system, a rotor position sensor is essential for controlling the power devices of the inverter. The main problem with present rotor position detection methods is cost and reliability of the sensor. This often takes the form of an optical encoder or a Hall-Effect sensor, which is prone to contamination or accidental damage.

This paper presents the design of a sensorless AC drive system, in which an implicit rotor position detection unit is used together with a simple fuzzy logic controller to adjust the voltage and frequency inputs of a PWM inverter.

2. PM motor control requirements

When a PM synchronous motor is driven by an inverter, the possible method of speed control is the frequency variation of the voltage applied to the motor. In this case, the motor speed (W) is directly proportional to the inverter output frequency (F);

$$W \propto F \quad (1)$$

When the frequency (F) is variable, a constant rms value of the phase voltage (V) will make the amplitude of resultant flux (φ) variable also[3];

$$V \propto F * \varphi \quad (2)$$

Now if frequency decreases with constant voltage, the resultant flux increases, therefore, in order to avoid magnetic saturation, it is essential to keep the voltage to frequency ratio (V_i/F_i) constant.

It is clear that increasing the supply frequency to increase the speed requires increasing the inverter output voltages in order to achieve constant resultant flux. Beyond the base speed, the torque decreases with an increase in the supply frequency, since the inverter DC link voltage reaches a maximum value.

At constant torque operating range, the developed torque is mainly function of the load angle (δ). Constant torque operation can be achieved if;

- the load angle is held constant, and
- the output voltage of the inverter is made to vary linearly with the required frequency.

The most commonly used controller for drive systems is the Proportional plus Integral plus Derivative (PID) controller, which requires an accurate mathematical model of the system. Fuzzy logic controller (FLC) provides an alternative to the PID controller, since it is a good selection for plants that are difficult in modeling [11].

3. Drive system components

The PM synchronous motor is becoming widely used as a speed and position control of a servo system. This device is generally driven by a 3-phase PWM inverter which converts a constant voltage to 3-phase voltages corresponding to the rotor position. Figure 1 shows the layout of the drive system components, it consists;

- PM Motor: an eight pole PM machine.
- Implicit Sensor: a rotor position sensor producing 24 pulses each revolution.

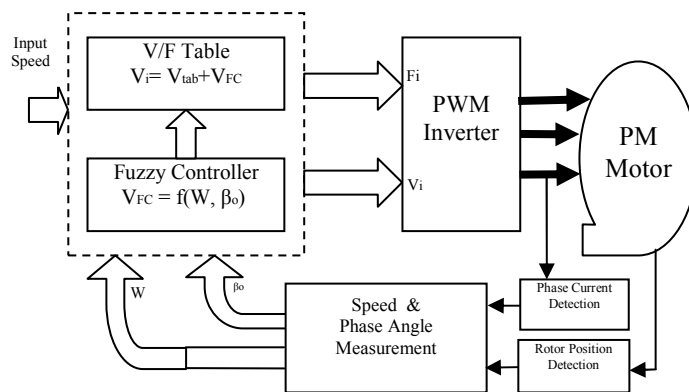
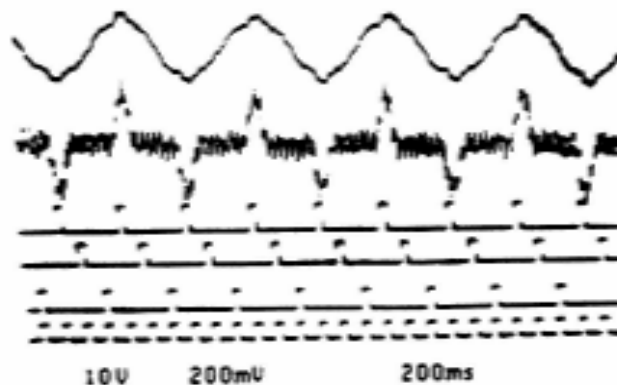

Fig. 1. Sensorless PM motor drive system.



Trace(1): Phase to phase voltage.
 Trace(2): Search coil induced voltage.
 Trace(3, 4,5): Rotor position signals from each phase.
 Trace(6): Combined rotor position signal.

Fig. 2. Implicit rotor detection signals.

- Speed Measurement: to provide online measurement of rotating speed (ω).
- Current Measurement: to monitor phase current (I).
- Load Measurement: to monitor the internal load angle (δ).
- PWM Inverter: sinusoidal PWM inverter.
- Microprocessor: to perform all tasks required for real-time operation.

3.1 Rotor position detection

In this system, there is no need for using any mechanical sensor for rotor position detection. An implicit sensor has been used for position, speed and load angle measurement. Three rotor position detection units are used to produce 24 pulses each revolution, as shown in Fig. 2. Each detection unit consists of three groups of single turn search coils inserted into the machine stator.

3.2 Speed measurement

The principle of this speed measurement method is to calculate the time between each consecutive pulses coming from the rotor position sensor. This is done by counting the number of clock pulses (C) coming from an external oscillator (Fs);

$$W = 2.5 F_s / C \quad (\text{rpm}) \quad (3)$$

In order to improve the accuracy and resolution of the speed measurement, the oscillator clock (Fs) is made proportional to the measured speed[9]. The speed measurement unit works well over a wide range of operation. It offers a fast and accurate speed measurement, which is suitable for real-time applications.

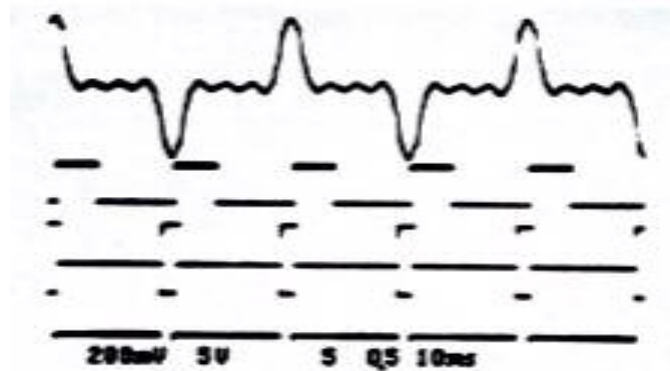

Trace(1): Search coil induced voltage.
Trace(2): Max resultant flux signal.
Trace(3): Rotor position signal.
Trace(4): Load angle signal.

Fig. 3. Load angle measurement.

3.3 Load angle measurement:

To measure the internal load angle (θ), it is necessary to monitor the rotor position with reference to no-load position. In this case, the maximum resultant gap flux signal is considered as the reference for comparison with the rotor position, as shown in Fig. 3. The induced voltage in a single turn search coil is used to detect the maximum resultant flux in the air-gap.

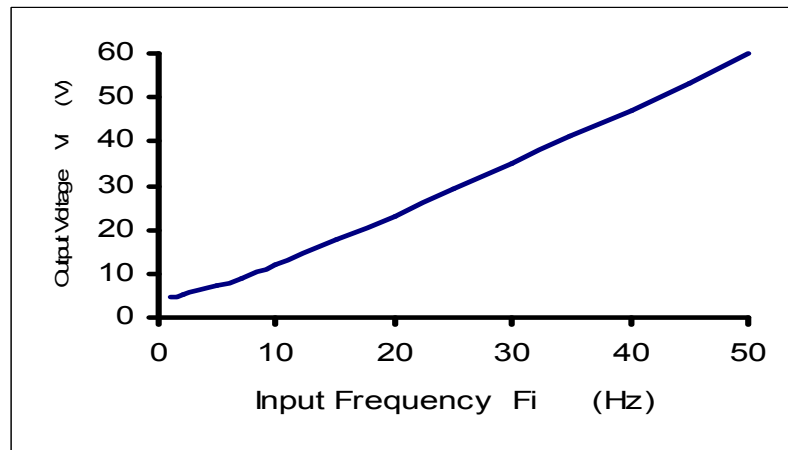

Fig. 4. Voltage/frequency curve of the PM motor.

3.3 PWM inverter

In the majority of sinusoidal PWM drive systems, the only two control signals are; the level of motor voltage, and the motor frequency. These two parameters are arranged to be independent control inputs into the inverter, so that each input can be adjusted without affecting the other. Figure 4 shows the voltage/frequency curve required for the PM motor under test.

4. Fuzzy logic controller

The PM synchronous motor drive, the best choice of control variable is the voltage level, since it does not affect the motor speed, and it has a direct effect on the phase current, system power factor and motor load angle[8].

A PM motor with sinusoidal applied voltage can be controlled by an open-loop approach, in which the inverter output voltage can be adjusted according to the rated Volt/Hertz ratio, Fig. 4, which ensures constant air-gap flux. The PM motor speed is always in synchronism with the supply frequency, but there

is a risk of pull-out at high torque or at variable speed operation. The efficiency of such a system can be improved by measuring the load angle and adjusting the output voltage of the inverter to minimize that current

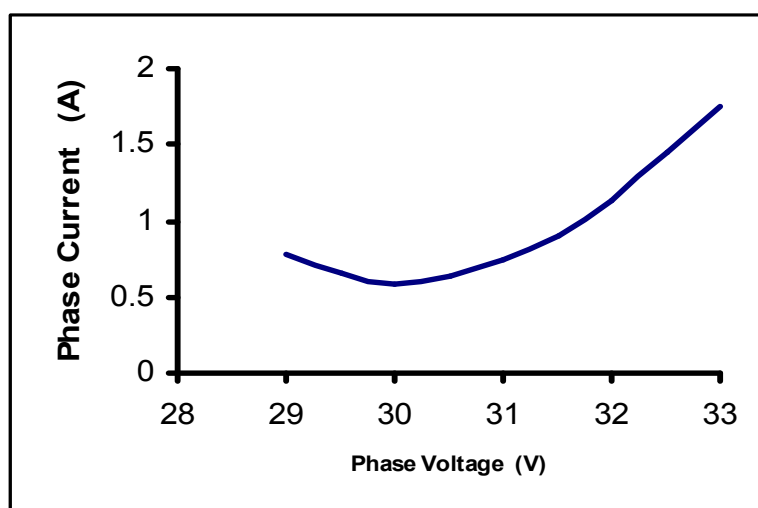

Fig. 5. Variation of phase current with phase voltage.

In most inverter-fed synchronous motor drive systems the control methods are usually based on phase current measurement. In this case, it is required to apply a search algorithm to obtain the minimum point. However, the minimum point in the phase current versus motor voltage curve, Fig. 5, tends to be flat, so there is a problem in obtaining the required voltage level.

An alternative method is possible if the load angle signal is used to adjust the output voltage of the inverter. In this research, the phase angle (β) between the phase current vector and rotor position signal is used as the feedback signal instead of the load angle (δ). The phase angle (β) produces information about the machine load and system power factor. This phase angle is to be measured and compared with the set value, then the difference (β_e) is used to adjust the voltage control command for the inverter.

A fuzzy logic controller (FLC) has been proposed to compute a signal (VFC) according to the calculated phase difference (β_e) and measured rotating speed (ω). In this FLC, the rotor speed (ω) and the phase difference (β_e) are chosen as the condition variables. The quantized input data is converted into suitable linguistic variables. In this paper, the following linguistic variables are used for the phase difference: Positive Large (PL), Positive Small (PS), Zero (Z), Negative Small (NS), and Negative Big (NL). While for the speed, the

following linguistic variables are used: Very High (VH), High (H), Medium (M), Low (L), and Very Low (VL). Figure 6 shows the universe of discourse and fuzzy sets of these variables. The fuzzy sets definition for the output are similar to the fuzzy set of the phase difference, where five sets (NB, NS, Z, PS, and PB) are used.

The FLC is in fact a collection of linguistic rules which describe the relationships between inputs (βe & W), and output (V_{FC}). These rules are represented by IF and THEN statement such as;

IF W is M and βe is PS THEN V_{FC} is NS

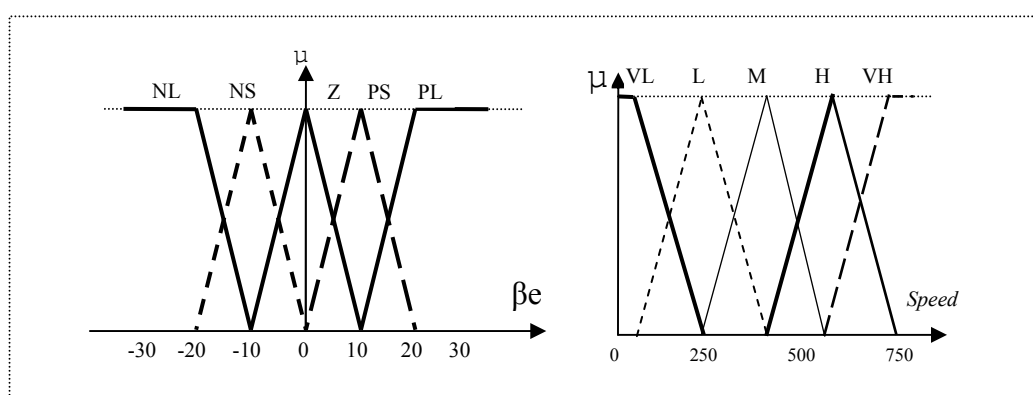

Fig. 6. Fuzzy sets and universe of discourse.

In this case, the FLC has two input variables (W and βe), and five membership function in each range, it may lead to a 5 *5 decision table, as shown in Table 1. The Mamdani-style inference process is used[12], and the center of gravity defuzzification method is applied to convert the fuzzy out into a crisp value.

Table 1. Rule table of the fuzzy logic controller.

| | NL | NS | Z | PS | PL |
|----|----|----|---|----|----|
| VL | Z | Z | Z | Z | Z |
| L | PS | Z | Z | Z | NS |
| M | PS | PS | Z | NS | NS |
| H | PL | PS | Z | NS | NL |
| VH | PL | PL | Z | NL | NL |

5. Real-time implementation

The most popular method of implementing rule-based fuzzy controller of a PM motor is using a microprocessor or a microcontroller. In this case, an 8-bit microprocessor system can handle most of the necessary computations. Microprocessor-based controllers are more suitable in dealing with real-time signals that require high processing and input/output handling speed.

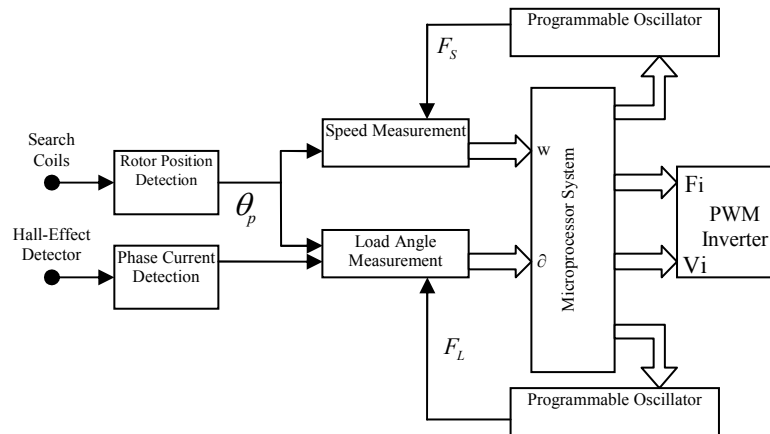

Fig. 7. Hardware design of the proposed drive system.

5.1 Hardware design

The general layout of the microprocessor-based sensorless drive system is illustrated in Fig. 7. The frequency (F_i) and voltage (V_i) input commands of the PWM inverter are controlled by the microprocessor according to the required speed, actual rotating speed (w) and measured load angle (δ). The microprocessor scans the rotating speed and the internal load angle through the input interface which consists of:

- Phase detection unit: a Hall-Effect detector has been used to detect phase current of the motor.
- Rotor detection unit: It produces 24 pulses each revolution, as shown in Fig. 3. The rotor position sensor output is used to cause an interrupt signal to the microprocessor. All the real-time tasks depend on this interrupt signal.
- Speed measurement unit: 16-bit counter is used to count the time between each consecutive pulses coming from rotor position detection unit. The counting pulses (F_s) generated from a programmable oscillator is made proportional to the measured speed (w).

- Load angle measurement: an 8-bit counter is used to measure the phase difference between maximum resultant gap flux signal and rotor position signal. The counting pulses (F_L) generated from a programmable oscillator is adjusted by the microprocessor to modify measurement accuracy. The load angle of the PM motor can be measured eight times per revolution, and has good accuracy and response.

According to the measured signals the microprocessor generates the required frequency and voltage commands (8-bit each) of the PWM inverter. Also, it updates the required data to the programmable oscillators to modify speed and load angle measurements.

5.2 Software design

For real-time operation, it is essential to arrange the overall system software such that the microprocessor does not become overloaded. Figure 8 illustrates the foreground/background software. The foreground tasks are written as an interrupt service routine, and the background tasks as a standard program.

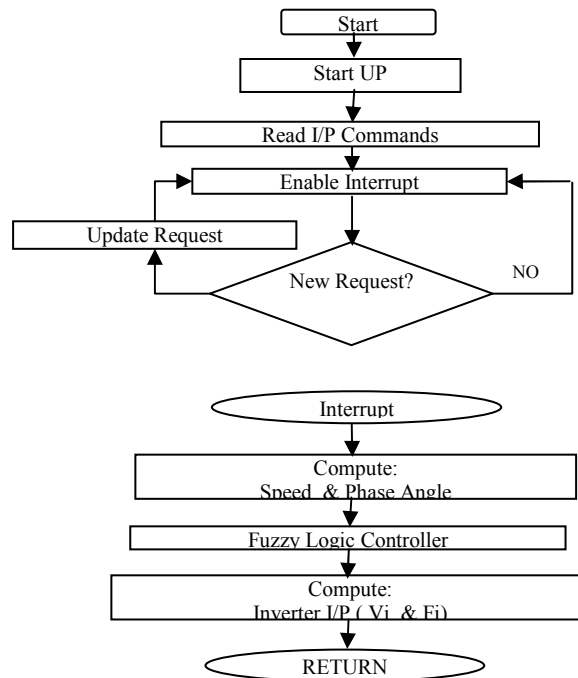

Fig. 8. Real-time software design.



Fig. 9. Speed response of the PM motor.

- Background software; which includes; system initialization, motor start-up, new request, and display update tasks.
- Foreground software; which includes; clock/calendar update, speed measurement, load angle measurement, and fuzzy logic control tasks.

The real-time response of the measurement and control tasks (about 5000 clock cycles) becomes critical at high speed, at which the sampling interval is only 1.667 msec. The rotor position is sampled 24 times per revolution, and both the load angle and the rotor speed 4 times per revolution.

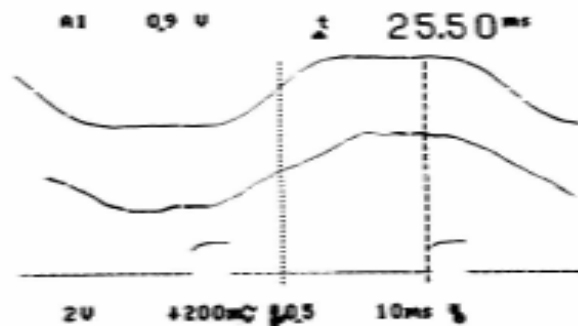

Trace(1): Phase voltage.
Trace(2): Phase current.
Trace(3): Rotor position signal.

Fig. 10. System waveforms at unity power factor.

6. Results

The proposed fuzzy controller has been tested with the sensorless PM drive system. The obtained results demonstrate that such a controller is able to drive the motor accurately for a wide range of operation. The operation of the PM motor drive system has been tested for step input with and without load. Figure 9 shows the motor speed response during acceleration and deceleration.

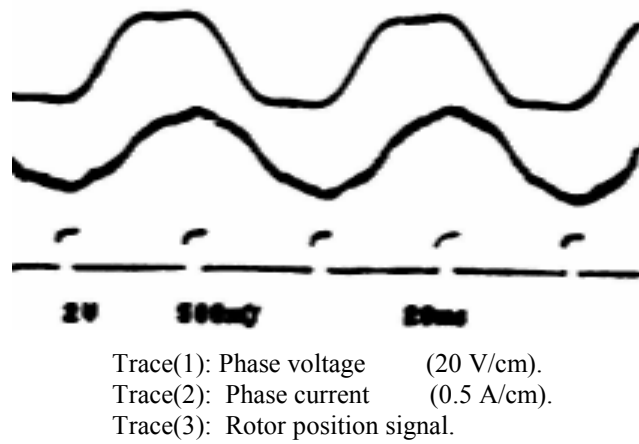

Fig. 11. System waveforms at lagging power factor.

When the PM motor was running at a fixed load angle and unity power factor, Fig. 10, the measurement of current phase angle and the load angle were the same. Figure 11 shows voltage and current waveforms, and rotor position signal when the machine is running at 0.83 lagging power factor. The measured feedback signal (b) is 106 electrical degrees. When the machine was running at 0.93 leading power factor, the measured feedback signal is 50 degrees electrical, as given in Fig.12. Therefore, there is a good variation in measured feedback signal with the power factor.

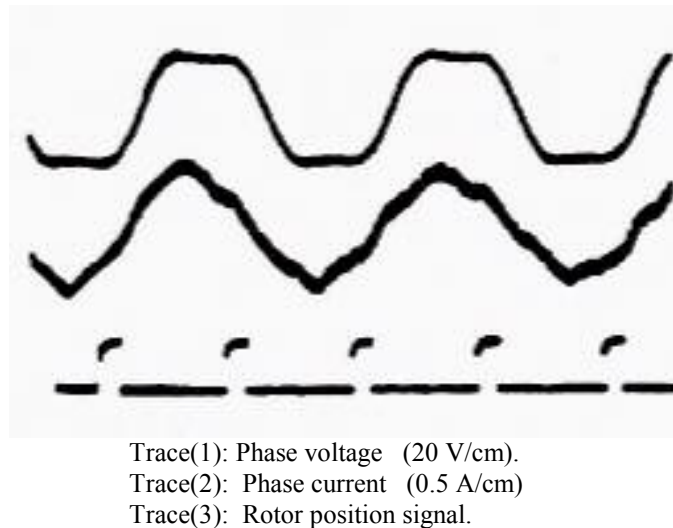

Fig. 12. System waveforms at leading power factor.

6. Conclusions

The overall system presented in this paper is a sensorless PM drive system, since there is no need for any mechanical sensor. The rotor position pulses derived from the implicit sensor (search coils) are used for position, speed and load measurements. The proposed control algorithm is simple and does not require accurate knowledge of the motor parameters, only the phase angle between phase current and rotor position signal are required. Such a controller is able to drive the motor accurately for a wide range of operation. This drive system is particularly suitable for applications where simplicity, reliability and stability are more important issues.

The accuracy of the drive system controller depends on the following:

- the word length of the microprocessor,
- the resolution of the PWM inverter,
- the fuzzy controller design, which is limited by the number of fuzzy sets, universe of discourse and rules used to specify relationships between voltage output and the measured speed and phase angle.

For future work, Field Programmable Gate Array (FPGA) devices can be used in implementing the hardware and software tasks of the rule-based fuzzy logic controller of the Sensorless drive systems.

References

- [1]. D. Finney. *Variable frequency AC motor drive systems*. Peter Peregrinus Ltd., IEE Books, UK 1988.
- [2]. C. G. Kim, J. H. Lee, S. K. Chung and M. J. Youn. A high precision speed control of BLDD motor using fuzzy logic controller. *Proceedings of the World Automation Congress (WAC'96), USA, May 1996, pp(389-396)*.
- [3]. B. K. Bose. *Microcomputer control of power electronics and drives*. IEEE Press, USA, 1987.
- [4]. L. M. C. Mahngo. Benefits of NdFeB magnet in brushless DC motor design for aircraft applications. *IEE 4th Intr. Conf. on Electr. Machines & drives, London, 1989, pp(76-79)*.
- [5]. N. A. Demerdash and T. W. Nehl. Dynamic modeling of brushless DC motors for aerospace actuation. *IEE Trans, Vol. AES-16, No.6, November 1980, pp(812-821)*.
- [6]. T. J. E. Mellor. *Brushless PM and reluctance motor drives*. Clarendon Press, Oxford, 1989.

- [7]. P. P. Acarrnley, A. G. Jack and P. T. Jowett. Speed stability in PM synchronous and brushless DC drives. *Conf. Rec. ICEM'88, Italy 1988, pp(23-28)*.
- [8]. K. J. Binns, K. M. Al-Aubidy and D. W. Shimmin. Implicit rotor position sensing using search coils for a self-commutating PM drive system. *IEE Proceedings, Vol.137, Pt.B, No.4, July 1990*.
- [9]. K. M. Al-Aubidy. Microcomputer-based new measurement technique of angular velocity for real-time applications. *IEEE Conf., [IECON'85], USA 1985*.
- [10]. S. Poorani, T. V. S. Urmila Priya, K. U. Kumar and S. Renganarayanan. FPGA based fuzzy logic controller for electric vehicle. *Journal of The Institute of Engineers, Singapore, Vol.45, No.5, 2005, pp.(1-14)*.
- [11]. C. G. Kim, J. H. Lee, S. K. Chung and M. J. Youn. A high precision speed control of BLDD motor using fuzzy logic controller. *Proceedings of the World Automation Congress (WAC'96), May 1996, pp.(389-396)*.
- [12]. M. Negnevitsky. *Artificial intelligence; a guide to intelligent systems*. Addison Wesley, USA 2002.



Kasim M. Al-Aubidy received his BSc and MSc degrees in control and computer engineering from the University of Technology, Iraq in 1979 and 1982, respectively, and the PhD degree in real-time computing from the University of Liverpool, England in 1989. He is currently the dean of the Faculty of Engineering at Philadelphia University, Jordan. His research interests include fuzzy logic, neural networks, genetic algorithm and their real-time applications. He was the winner of Philadelphia Award for the best researcher in 2000. He is the chief editor of two international journals;

the Asian Journal of Information Technology, and international journal of softcomputing. He is also a member of editorial board of international journals. He has coauthored 5 books and published 59 papers on topics related to computer applications.

[Address:](#) Dr. Kasim M. Al-Aubidy, The Dean, Faculty of Engineering, Philadelphia University, P O Box 1, Jordan 19393. Email: alaubidy@gmail.com